

1250/1300 Volt PSC Square Body

Mersen 1250/1300V PSC fuse-links provide maximum flexibility in equipment design and ultimate protection for today's power conversion equipment. These square body fuse-links are available in four different body sizes, each size having four worldwide acceptable mounting styles. The different mounting styles and body sizes along with a broad range of ampere ratings allow greatest flexibility in equipment design.

Mersen PSC fuses have been engineered to provide state-of-the-art protection for SCR's, diodes, thyristors, GTO's and IGBT devices. They have pure silver die-cut elements embedded in solidified sand which helps control arcing characteristics for low I^2t and high interrupting rating. All contact surfaces are silver plated and all hardware is non-magnetic.

All fuse links are equipped with a low voltage trip-indicator. This trip-indicator can operate a field mountable microswitch which is easily mounted directly onto the fuse even while in service.

Features/Benefits:

- Choice of mounting styles gives wide choice for equipment design
- Broad range of ampere ratings in a given body size for design flexibility
- IEC 269-4 compliance for fuses for worldwide semiconductor applications

*For Microswitch information see page J9

Highlights:

- Extremely fast acting
- Current limiting
- Very low I^2t
- Superior cycling ability

Applications:

- Protection of rectifiers, inverters, DC drives, UPS Systems, reduced voltage motor starters, and other equipment in globally accepted applications



Ratings:

- Volts** : 650-1300 VAC
- Amps** : AC - 50-1800A
- I.R.** : 100kA I.R. AC
- DC** : Consult Factory

Approvals:

- UL recognized component File E76491
- Sizes 70,71,72,73 tested to IEC 269.4



Part Number Designation:

12,5 URD: European/IEC
Mounting Style/Approval
Tested @ 1.1 V_N

A130 URD: North American
Mounting Style/Approval
Tested @ V_N

* V_N = rated voltage

N. American Reference Numbering System

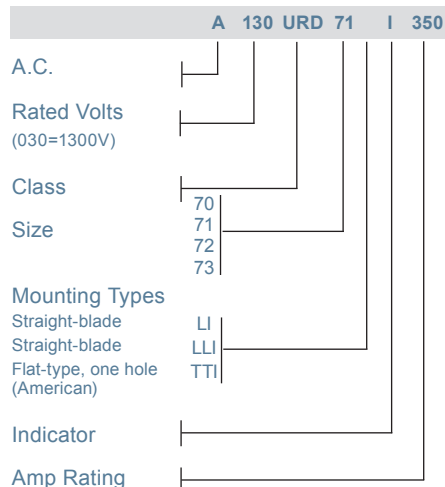

European Reference Numbering System

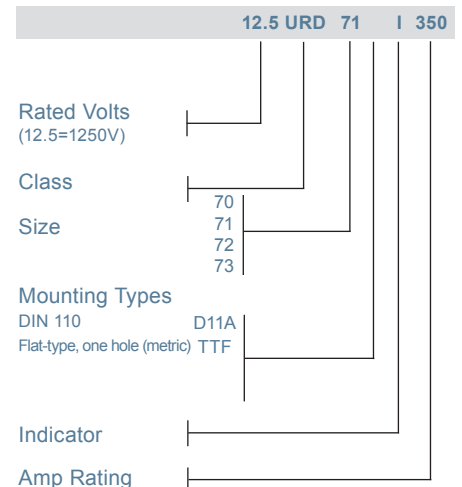

1250/1300 Volt PSC Square Body

European Blade DIN 110, Type D11A

Body Size	Type	Dimensions - mm (in)						
		A	B	C	D	E	F	G
70	D11	40 (1.57)	25 (.98)	12.5 (.49)	21 (.83)	17 (.67)	100.4 (3.95)	133.4 (5.25)
71		51 (2.01)	25 (.98)	12.5 (.49)	25.5 (1.00)	22.5 (.89)	100.4 (3.95)	133.4 (5.25)
72		60 (2.36)	32 (1.26)	16 (.63)	30 (1.18)	27 (1.06)	100.4 (3.95)	133.4 (5.25)
73		74.5 (2.93)	40 (1.57)	20 (.79)	37.2 (1.46)	34.25 (1.35)	100.4 (3.95)	133.4 (5.25)

North American Straight Blade, Types LI & LLI

Body Size	Type	Dimensions - mm (in)								
		A	B	C	D	E	F	G	H	J
70	LI	40	25	12.5	21	18	91.4	130.4	152.4	10.5
		(1.57)	(0.98)	(0.49)	(0.83)	(0.71)	(3.60)	(5.13)	(6.00)	(0.41)
71	LLI	51	25	12.5	25.5	22.5	91.4	130.4	152.4	14.6
		(2.01)	(0.98)	(0.49)	(1.00)	(0.89)	(3.60)	(5.13)	(6.00)	(0.57)
72	LI	60	32	16	30	27	97.6	132.4	157.4	14.6
		(2.36)	(1.26)	(0.63)	(1.18)	(1.06)	(3.84)	(5.2)	(6.20)	(0.57)
73	LI	74.5	40	20	37.2	34.2	98.8	132.4	157.4	15.9
		(2.93)	(1.57)	(0.79)	(1.46)	(1.35)	(3.89)	(5.21)	(6.20)	(0.63)

Outline Dimensions

Type D11A

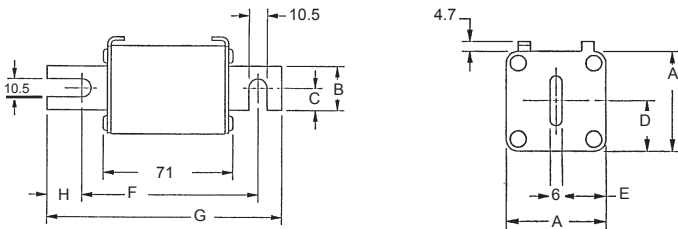

Types LI and LLI

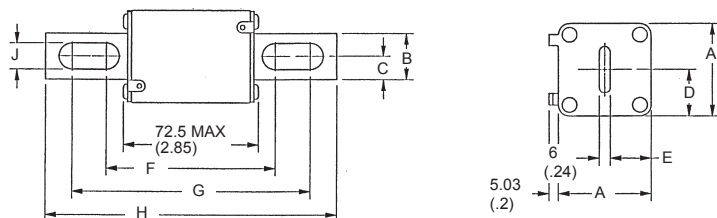

1250/1300 Volt PSC Square Body

1250/1300 Volt North American and European Flat Single Hole, Type TTI/TTF

Body Size	Type	Dimensions - mm/(In)		Tapped Hole (N. A.)	Tapped Hole (EURO.)
		A	B	C (TTI)	D (TTF)
70	TTI/TTF	40 (1.57)	25 (1.00)	5/16-18 X .23DP	M8 X 1.25 X 6 DP
71		50.8 (2.00)	30.2 (1.19)	5/16-18 X .36DP	M8 X 1.25 X 9 DP
72		60.3 (2.37)	38.1 (1.50)	3/8-16 X .36DP	M10 X 1.50 X 9 DP
73		74.6 (2.94)	46 (1.81)	1/2-13 X .35DP	M12 X 1.75 X 9 DP

Types TTI and TTF

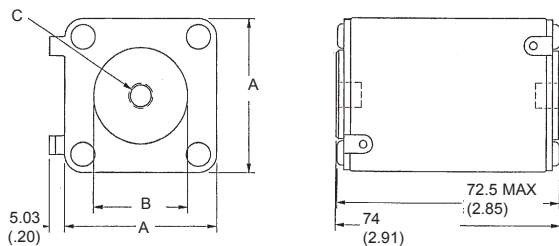

Standard Threaded Studs

Size	Ref. and Dimension Per Pair of Studs	Weight (g)	Max Stud Mounting Torque (Nm)	Max Nut Tightening Torque (Nm)		
				Fig. 1	Fig. 2	Fig. 3
70 & 71	S 98 801 (HC M8 X 30 & M 8 X 35)	23	13	13.5	13.5	13.5
72	T 98 802 (HC M 10 X 30 & M 10 X 50)	40	15	26	26	26
73	V 98 803 (HC M 12 X 35 & M 12 X 50)	60		46	46	15
2X72	W 98 804 (HC M 10 X 50)	50		26	26	26
2X73	X 98 805 (HC M 12 X 50)	70		46	46	15

Packaging: 6 pairs

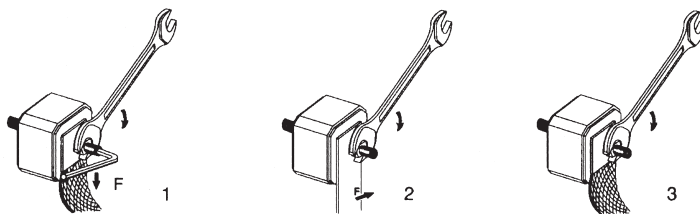

1250/1300 Volt PSC Square Body

1250 Volt European/IEC Style Ratings and Application Data, D11A Mounting

Body Size	Amp Rating	Rated Voltage	Melting I ² t (A ² s x 10 ³)	Total I ² t @ 660VAC (A ² s x 10 ³)	** Watts Loss @ Rated Current (W)	Catalog No	New Description	Old Description
70	50	1250	0.116	0.98	16	J301906	PC70UD13C50D1A	12,5URD70D11A0050
	63	1250	0.21	1.7	26	V300536	PC70UD13C63D1A	12,5URD70D11A0063
	80	1250	0.47	3.8	27	W300537	PC70UD13C80D1A	12,5URD70D11A0080
	100	1250	0.83	6.7	30	X300538	PC70UD13C100D1A	12,5URD70D11A0100
	125	1250	1.3	10.5	38	Y300539	PC70UD13C125D1A	12,5URD70D11A0125
	160	1250	2.5	21	45	Z300540	PC70UD13C160D1A	12,5URD70D11A0160
	200	1250	4.7	37.8	54/56	A300541	PC70UD13C200D1A	12,5URD70D11A0200
	250	1250	9.6	77	58/61	B300542	PC70UD13C250D1A	12,5URD70D11A0250
	280	1200	14	107	61	J300710	PC70UD12C280D1A	12URD70D11A0280
	315	1200	20	150	66	C300543	PC70UD12C315D1A	12URD70D11A0315
	350	1100	28	180	68/75	D300544	PC70UD11C350D1A	11URD70D11A0350
	400	1100	39	254	81	F300868	PC70UD11C400D1A	11URD70D11A0400
71	160	1250	2.6	21	46	D300751	PC71UD13C160D1A	12,5URD71D11A0160
	200	1250	4.7	38	54	E300545	PC71UD13C200D1A	12,5URD71D11A0200
	250	1250	8.9	71	61	F300546	PC71UD13C250D1A	12,5URD71D11A0250
	315	1250	16	130	73/76	G300547	PC71UD13C315D1A	12,5URD71D11A0315
	350	1250	22	180	76/80	H300548	PC71UD13C350D1A	12,5URD71D11A0350
	400	1250	38	310	76/80	J300549	PC71UD13C400D1A	12,5URD71D11A0400
	450	1250	47	380	87/95	K300550	PC71UD13C450D1A	12,5URD71D11A0450
	500	1100	68	440	90/100	L300551	PC71UD11C500D1A	11URD71D11A0500
	550	1100	84	540	98/112	M300552	PC71UD11C550D1A	11URD71D11A0550
	630	1000	125	810	105	N300553	PC71UD10C630D1A	10URD71D11A0630
72	280	1250	10	84	72	P300554	PC72UD13C280D1A	12,5URD72D11A0280
	315	1250	15	122	76	Q300555	PC72UD13C315D1A	12,5URD72D11A0315
	350	1250	21	170	77	R300556	PC72UD13C350D1A	12,5URD72D11A0350
	400	1250	32.5	270	80	S300557	PC72UD13C400D1A	12,5URD72D11A0400
	450	1250	44	360	87/89	T300558	PC72UD13C450D1A	12,5URD72D11A0450
	500	1250	57	460	94/98	V300559	PC72UD13C500D1A	12,5URD72D11A0500
	550	1250	68	550	110/120	W300560	PC72UD13C550D1A	12,5URD72D11A0550
	630	1100	105	850	113	X300561	PC72UD11C630D1A	11URD72D11A0630
	700	1000	145	910	122	Y300562	PC72UD10C700D1A	10URD72D11A0700
	800	1000	215	1400	125	Z300563	PC72UD10C800D1A	10URD72D11A0800
	900	1000	312	1800	130	H300870	PC72UD10C900D1A	10URD72D11A0900
73	315	1250	12	95	84	A300564	PC73UD13C315D1A	12,5URD73D11A0315
	350	1250	117	140	86	B300565	PC73UD13C350D1A	12,5URD73D11A0350
	400	1250	25	200	93	C300566	PC73UD13C400D1A	12,5URD73D11A0400
	450	1250	35.5	290	99/100	D300567	PC73UD13C450D1A	12,5URD73D11A0450
	500	1250	44	360	110/112	E300568	PC73UD13C500D1A	12,5URD73D11A0500
	550	1250	57	460	116/120	F300569	PC73UD13C550D1A	12,5URD73D11A0550
	630	1250	84	680	125/132	G300570	PC73UD13C630D1A	12,5URD73D11A0630
	700	1200	110	900	135	H300571	PC73UD12C700D1A	12URD73D11A0700
	800	1100	190	1530	136	J300572	PC73UD11C800D1A	11URD73D11A0800
	900	1000	250	1870	150	K300573	PC73UD10C900D1A	10URD73D11A0900
	1000	900	370	2130	152	L300574	PC73UD90V10CD1A	9URD73D11A1000
	1100	900	445	2470	168	M300575	PC73UD90V11CD1A	9URD73D11A1100

** Watts loss data is published for both blade and tapped style mounting configurations. When two watts loss values are shown this represents tapped/blade values respectively.

1250/1300 Volt PSC Square Body

1250 Volt European/IEC Style Ratings and Application Data, TTF Mounting

Body Size	Amp Rating	Rated Voltage	Melting I ² t (A ² s x 10 ³)	Total I ² t @ 660VAC (A ² s x 10 ³)	** Watts Loss @ Rated Current (W)	Catalog No	New Description	Old Description
70	50	1250	0.116	0.98	16	C301095	PC70UD13C50TF	12,5URD70TTF0050
	63	1250	0.21	1.7	26	M300483	PC70UD13C63TF	12,5URD70TTF0063
	80	1250	0.47	3.8	27	N300484	PC70UD13C80TF	12,5URD70TTF0080
	100	1250	0.83	6.7	30	P300485	PC70UD13C100TF	12,5URD70TTF0100
	125	1250	1.3	10.5	38	Q300486	PC70UD13C125TF	12,5URD70TTF0125
	160	1250	2.5	21	45	R300487	PC70UD13C160TF	12,5URD70TTF0160
	200	1250	4.7	37.8	54/56	S300488	PC70UD13C200TF	12,5URD70TTF0200
	250	1250	9.6	77	58/61	T300489	PC70UD13C250TF	12,5URD70TTF0250
	280	1200	14	107	64	N300714	PC70UD12C280TF	12URD70TTF0280
	315	1200	20	150	72	V300490	PC70UD12C315TF	12URD70TTF0315
	350	1100	28	180	68/75	W300491	PC70UD11C350TF	11URD70TTF0350
400	1100	39	254	81	E300867	PC70UD11C400TF	11URD70TTF0400	
71	160	1250	2.6	21	46	B300749	PC71UD13C160TF	12,5URD71TTF0160
	200	1250	4.7	38	54	Z300517	PC71UD13C200TF	12,5URD71TTF0200
	250	1250	8.9	71	61	A300518	PC71UD13C250TF	12,5URD71TTF0250
	315	1250	16	130	73/76	B300519	PC71UD13C315TF	12,5URD71TTF0315
	350	1250	22	180	76/80	C300520	PC71UD13C350TF	12,5URD71TTF0350
	400	1250	38	310	76/80	D300521	PC71UD13C400TF	12,5URD71TTF0400
	450	1250	47	380	87/95	E300522	PC71UD13C450TF	12,5URD71TTF0450
	500	1100	68	440	90/100	F300523	PC71UD11C500TF	11URD71TTF0500
	550	1100	84	540	98/112	G300524	PC71UD11C550TF	11URD71TTF0550
630	1100	125	810	120	H300525	PC71UD11C630TF	11URD71TTF0630	
72	280	1250	10	84	72	Y300493	PC72UD13C280TF	12,5URD72TTF0280
	315	1250	15	122	76	Z300494	PC72UD13C315TF	12,5URD72TTF0315
	350	1250	21	170	77	A300495	PC72UD13C350TF	12,5URD72TTF0350
	400	1250	32.5	270	80	B300496	PC72UD13C400TF	12,5URD72TTF0400
	450	1250	44	360	87/89	C300497	PC72UD13C450TF	12,5URD72TTF0450
	500	1250	57	460	94/98	D300498	PC72UD13C500TF	12,5URD72TTF0500
	550	1250	68	550	110/120	E300499	PC72UD13C550TF	12,5URD72TTF0550
	630	1250	105	850	125	F300500	PC72UD13C630TF	12,5URD72TTF0630
	700	1100	145	910	140	G300501	PC72UD11C700TF	11URD72TTF0700
	800	1100	215	1400	146	H300502	PC72UD11C800TF	11URD72TTF0800
	900	1000	312	1800	130	G300869	PC72UD10C900TF	10URD72TTF0900
1000	850	-	-	136	T301294	PC72UD85V1000TF	8,5URD72TTF1000	
73	315	1250	12	95	84	J300503	PC73UD13C315TF	12,5URD73TTF0315
	350	1250	17	140	86	K300504	PC73UD13C350TF	12,5URD73TTF0350
	400	1250	25	200	93	L300505	PC73UD13C400TF	12,5URD73TTF0400
	450	1250	35.5	290	99/100	M300506	PC73UD13C450TF	12,5URD73TTF0450
	500	1250	44	360	110/112	N300507	PC73UD13C500TF	12,5URD73TTF0500
	550	1250	57	460	116/120	P300508	PC73UD13C550TF	12,5URD73TTF0550
	630	1250	84	680	125/132	Q300509	PC73UD13C630TF	12,5URD73TTF0630
	700	1250	110	900	146	R300510	PC73UD13C700TF	12,5URD73TTF0700
	800	1250	190	1530	148	S300511	PC73UD13C800TF	12,5URD73TTF0800
	900	1200	250	1870	170	T300512	PC73UD12C900TF	12URD73TTF0900
	1000	1000	370	2130	174	V300513	PC73UD10C1000TF	10URD73TTF1000
	1100	950	445	2470	208	W300514	PC73UD95V11CTF	9,5URD73TTF1100
	1250	900	585	3050	186/200	T300696	PC73UD90V13CTF	9URD73TTF1250
	1400	850	755	3700	210/228	S300718	PC73UD85C14CTF	8,5URD73TTF1400
1600	660	1430	5630	203	N304417			
1800	600	2040	7600	206	C301302	PC73UD60V18CTF	6URD73TTF1800	

** Watts loss data is published for both blade and tapped style mounting configurations. When two watts loss values are shown this represents tapped/blade values respectively.

1250/1300 Volt PSC Square Body

1300 Volt North American Style Ratings and Application Data, LI, LLI Mounting

Body Size	Amp Rating	Rated Voltage	Melting I ² t (A ² s x 10 ³)	Total I ² t @ 660VAC (A ² s x 10 ³)	** Watts Loss @ Rated Current (W)	Catalog No	New Description	Old Description
70	63	1300	0.21	1.8	26	W300652	A130UD70LI063	A130URD70LI0063
	80	1300	0.47	4	27	X300653	A130UD70LI080	A130URD70LI0080
	100	1300	0.83	7.2	30	Y300654	A130UD70LI100	A130URD70LI0100
	125	1300	1.3	11	38	Z300655	A130UD70LI125	A130URD70LI0125
	160	1300	2.5	22	45	A300656	A130UD70LI160	A130URD70LI0160
	200	1300	4.7	40	54/56	B300657	A130UD70LI200	A130URD70LI0200
	250	1300	9.6	82	58/61	C300658	A130UD70LI250	A130URD70LI0250
	315	1300	20	172	66/72	D300659	A130UD70LI315	A130URD70LI0315
	350	1200	28	205	68/75	E300660	A120UD70LI350	A120URD70LI0350
71	160	1300	2.6	22	46	E300752	A130UD71LLI160	A130URD71LLI0160
	200	1300	4.7	40	54	F300661	A130UD71LLI200	A130URD71LLI0200
	250	1300	8.9	76	61	G300662	A130UD71LLI250	A130URD71LLI0250
	280	1300	12	102	68/70	R300717	A130UD71LLI280	A130URD71LLI0280
	315	1300	16	138	73/76	H300663	A130UD71LLI315	A130URD71LLI0315
	350	1300	22	190	76/80	J300664	A130UD71LLI350	A130URD71LLI0350
	400	1300	38	330	76/80	K300665	A130UD71LLI400	A130URD71LLI0400
	450	1300	47	405	87/95	L300666	A130UD71LLI450	A130URD71LLI0450
	500	1200	68	500	90/100	M300667	A120UD71LLI500	A120URD71LLI0500
	550	1200	84	620	98/112	N300668	A120UD71LLI550	A120URD71LLI0550
630	1100	125	930	105	P300669	A110UD71LLI630	A110URD71LLI0630	
72	280	1300	10	90	72	Q300670	A130UD72LI280	A130URD72LI0280
	315	1300	15	130	76	R300671	A130UD72LI315	A130URD72LI0315
	350	1300	21	180	77	S300672	A130UD72LI350	A130URD72LI0350
	400	1300	32	285	80	T300673	A130UD72LI400	A130URD72LI0400
	450	1300	44	380	87/89	V300674	A130UD72LI450	A130URD72LI0450
	500	1300	57	500	94/98	W300675	A130UD72LI500	A130URD72LI0500
	550	1300	68	590	110/120	X300676	A130UD72LI550	A130URD72LI0550
	630	1200	105	920	113	Y300677	A120UD72LI630	A120URD72LI0630
	700	1100	145	1040	122	Z300678	A110UD72LI700	A110URD72LI0700
800	1100	215	1590	125	A300679	A110UD72LI800	A110URD72LI0800	
73	315	1300	12	102	84	B300680	A130UD73LI315	A130URD73LI0315
	350	1300	17	150	86	C300681	A130UD73LI350	A130URD73LI0350
	400	1300	25	220	93	D300682	A130UD73LI400	A130URD73LI0400
	450	1300	35	310	99/100	E300683	A130UD73LI450	A130URD73LI0450
	500	1300	44	390	110/112	F300684	A130UD73LI500	A130URD73LI0500
	550	1300	57	500	116/120	G300685	A130UD73LI550	A130URD73LI0550
	630	1300	84	730	125/132	H300686	A130UD73LI630	A130URD73LI0630
	700	1300	110	960	135/146	J300687	A130UD73LI700	A130URD73LI0700
	800	1200	190	1630	136	V301824	A130UD73LI800	A130URD73LI0800
	900	1100	250	2160	150	L300689	A110UD73LI900	A110URD73LI0900
	1000	1000	370	2430	152/174	M300690	A100UD73LI1000	A100URD73LI1000
	1100	1000	445	2580	168/208	N300691	A100UD73LI1100	A100URD73LI1100
	1250	1000	585	3480	186/200	J301193	A100UD73LI1250	A100URD73LI1250
	1400	900	755	3880	210/228	K301194	A090UD73LI1400	A090URD73LI1400
	1600	700	1430	5630	203	P300876	A070UD73LI1600	A070URD73LI1600
1800	650	2040	7600	206	A301599	A065UD73LI1800	A065URD73LI1800	

** Watts loss data is published for both blade and tapped style mounting configurations. When two watts loss values are shown this represents tapped/blade values respectively.

1250/1300 Volt PSC Square Body

1300 Volt North American Style Ratings and Application Data, TTI Mounting

Body Size	Amp Rating	Rated Voltage	Melting I ² t (A ² s x 10 ³)	Total I ² t @ 660VAC (A ² s x 10 ³)	** Watts Loss @ Rated Current (W)	Catalog No	New Description	Old Description
70	63	1300	0.21	1.8	26	Q301015	A130UD70TTI63	A130URD70TTI0063
	80	1300	0.47	4	27	R301016	A130UD70TTI80	A130URD70TTI0080
	100	1300	0.83	7.2	30	S301017	A130UD70TTI100	A130URD70TTI0100
	125	1300	1.3	11	38	T301018	A130UD70TTI125	A130URD70TTI0125
	160	1300	2.5	22	45	V301019	A130UD70TTI160	A130URD70TTI0160
	200	1300	4.7	40	54/56	W301020	A130UD70TTI200	A130URD70TTI0200
	250	1300	9.6	82	58/61	X301021	A130UD70TTI250	A130URD70TTI0250
	315	1300	20	172	66/72	Z301023	A130UD70TTI315	A130URD70TTI0315
	350	1200	28	205	68/75	A301024	A120UD70TTI350	A120URD70TTI0350
71	160	1300	2.6	22	46	B301025	A130UD71TTI160	A130URD71TTI0160
	200	1300	4.7	40	54	C301026	A130UD71TTI200	A130URD71TTI0200
	250	1300	8.9	76	61	D301027	A130UD71TTI250	A130URD71TTI0250
	280	1300	12	102	68/70	E301028	A130UD71TTI280	A130URD71TTI0280
	315	1300	16	138	73/76	F301029	A130UD71TTI315	A130URD71TTI0315
	350	1300	22	190	76/80	G301030	A130UD71TTI350	A130URD71TTI0350
	400	1300	38	330	76/80	H301031	A130UD71TTI400	A130URD71TTI0400
	450	1300	47	405	87/95	J301032	A130UD71TTI450	A130URD71TTI0450
	500	1200	68	500	90/100	K301033	A130UD71TTI500	A130URD71TTI0500
72	550	1200	84	620	98/112	L301034	A120UD71TTI550	A120URD71TTI0550
	630	1200	125	930	120	M301035	A120UD71TTI630	A120URD71TTI0630
	280	1300	10	90	72	N301036	A130UD72TTI280	A130URD72TTI0280
	315	1300	15	130	76	P301037	A130UD72TTI315	A130URD72TTI0315
	350	1300	21	180	77	Q301038	A130UD72TTI350	A130URD72TTI0350
	400	1300	32	285	80	R301039	A130UD72TTI400	A130URD72TTI0400
	450	1300	44	380	87/89	S301040	A130UD72TTI450	A130URD72TTI0450
	500	1300	57	500	94/98	T301041	A130UD72TTI500	A130URD72TTI0500
	550	1300	68	590	110/120	V301042	A130UD72TTI550	A130URD72TTI0550
73	630	1300	105	920	125	W301043	A130UD72TTI630	A130URD72TTI0630
	700	1200	145	1040	140	X301044	A120UD72TTI700	A120URD72TTI0700
	800	1200	215	1590	146	Y301045	A120UD72TTI800	A120URD72TTI0800
	315	1300	12	102	84	Z301046	A130UD73TTI315	A130URD73TTI0315
	350	1300	17	150	86	A301047	A130UD73TTI350	A130URD73TTI0350
	400	1300	25	220	93	B301048	A130UD73TTI400	A130URD73TTI0400
	450	1300	35	310	99/100	C301049	A130UD73TTI450	A130URD73TTI0450
	500	1300	44	390	110/112	D301050	A130UD73TTI500	A130URD73TTI0500
	550	1300	57	500	116/120	E301051	A130UD73TTI550	A130URD73TTI0550
73	630	1300	84	730	125/132	F301052	A130UD73TTI630	A130URD73TTI0630
	700	1300	110	960	135/146	G301053	A130UD73TTI700	A130URD73TTI0700
	800	1300	190	1630	148	H301054	A130UD73TTI800	A130URD73TTI0800
	900	1300	250	2160	170	T1013903	A130UD73TTI900	A130URD73TTI0900
	1000	1000	370	2430	152/174	K301056	A110UD73TTI1000	A110URD73TTI1000
	1100	1000	445	2580	168/208	V302192	A110UD73TTI1100	A110URD73TTI1100
	1250	1000	585	3480	186/200	M301058	A100UD73TTI1250	A100URD73TTI1250
	1400	900	755	3880	210/228	N301059	A090UD73TTI1400	A090URD73TTI1400
	1600	700	1430	5630	203	Q300877	A070UD73TTI1600	A070URD73TTI1600
1800	650	2040	7600	206	R300878	A065UD73TTI1800	A065URD73TTI1800	

** Watts loss data is published for both blade and tapped style mounting configurations. When two watts loss values are shown this represents tapped/blade values respectively.

For the most current product performance data visit ep-us.mersen.com and use catalog search.

1250/1300 Volt PSC Square Body

1250/1300Volt, 2x72, 2x73 Semiconductor Protection Fuses

Size	Catalog No	New Description	Old Description	Weight (g)	
73	H300640	PC73UD13C315PP4	12,5URD73PPAF0315	1250	
	J300641	PC73UD13C350PP4	12,5URD73PPAF0350		
	K300642	PC73UD13C405PP4	12,5URD73PPAF0400		
	L300643	PC73UD13C450PP4	12,5URD73PPAF0450		
	M300644	PC73UD13C500PP4	12,5URD73PPAF0500		
	N300645	PC73UD13C550PP4	12,5URD73PPAF0550		
	P300646	PC73UD13C630PP4	12,5URD73PPAF0630		
	Q300647	PC73UD13C700PP4	12,5URD73PPAF0700		
	R300648	PC73UD13C800PP4	12,5URD73PPAF0800		
	S300649	PC73UD12C900PP4	12URD73PPAF0900		
	T300650	PC73UD10C10CPP4	10URD73PPAF1000		
	V300651	PC73UD95V11CPP4	9,5URD73PPAF1100		
	T300719	PC73UD90V13CPP4	9URD73PPAF1250		
	V300720	PC73UD85V14CPP4	8,5URD73PPAF1400		
2 X 72	W300721	PC272UD13C630TF	12,5URD272TTF0630	1750	
	X300722	PC272UD13C700TF	12,5URD272TTF0700		
	Y300723	PC272UD13C800TF	12,5URD272TTF0800		
	Z300724	PC272UD13C900TF	12,5URD272TTF0900		
	A300725	PC272UD13C10CTF	12,5URD272TTF1000		
	B300726	PC272UD13C11CTF	12,5URD272TTF1100		
	M302231	PC272UD11C13CTF	11URD272TTF1250		
	D300728	PC272UD11C14CTF	11URD272TTF1400		
	L302230	PC272UD10C16CTF	10URD272TTF1600		
	E301994	PC272UD90V18CTF	9URD272TTF1800		
2 X 73	F301995	PC272UD75V20CTF	7,5URD272TTF2000	1900	
	G301996	PC272UD65V22CTF	6,5URD272TTF2200		
	H301997	PC272UD65V25CTF	6,5URD272TTF2500		
	F300730	PC273UD13C800TF	12,5URD273TTF0800		2600
	G300731	PC273UD13C900TF	12,5URD273TTF0900		
	H300732	PC273UD13C10CTF	12,5URD273TTF1000		
	J300733	PC273UD13C11CTF	12,5URD273TTF1100		
	K300734	PC273UD13C13CTF	12,5URD273TTF1250		
	K302229	PC273UD11C14CTF	11URD273TTF1400		
	J302228	PC273UD11C16CTF	11URD273TTF1600		
S302236	PC273UD11C18CTF	11URD273TTF1800			
P300738	PC273UD10C20CTF	10URD273TTF2000	2800		
Q300739	PC273UD95V22CTF	9,5URD273TTF2200			
M301909	PC76UD95V22CP11	9,5URD273PLAF2200		2700	
R300740	PC76UD90V25CP11	9URD273PLAF2500			
S300741	PC76UD85V28CP11	8,5URD273PLAF2800			
K301999	PC76UD60V30CP11	6URD273PLAF3000			
M302001	PC76UD60V32CP11	6URD273PLAF3200			
N302002	PC76UD55V36CP11	5,5URD273PLAF3600			

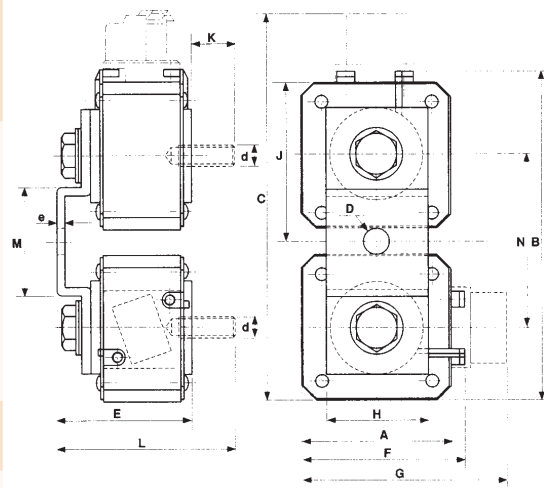

Microswitches and threaded studs supplied separately (see pages J8)

SIZE	A	B	C	D	E	F	G	H	J	K	d	e	L	M	N
2 X 72 TTF	60	138,5	172	11	91	65,5	100	35	66	39	M 10	4	131	48	72
2 X 73 TTF	74,5	167	200	13	91	79,6	114	50	80	39	M 12	4	131	54	86

Dimensions in / mm